

RS-8

RS-10

Reference Series (RS)
Floorstanding Speaker System

Owner's Manual

Part #334684-001



TABLE OF CONTENTS

- Caution.....3
- Important Safety Instructions.....4
- The Reference Series (RS)5
- Unpacking the Speakers.....5
- Installing Feet5
- Planning Your System6
 - Stereo-Speaker Placement6
 - Home-Theater Placement.....6
- Wiring the System7-8
 - Turn Off All Power.....7
- Final Adjustments9
- Care of Your Subwoofer9
- Troubleshooting10
- Specifications11

CAUTION

RISK OF ELECTRIC SHOCK DO NOT OPEN

WARNING: SHOCK HAZARD, DO NOT OPEN.
AVIS: RISQUE DE CHOC ELECTIQUE – NE PAS OUVRIR.
CUIDADO: PELIGRO DE CHOQUE ELÉCTRICO – NO ABRIR.

**CAUTION: TO REDUCE THE RISK OF ELECTRIC SHOCK
DO NOT REMOVE COVER (OR BACK)
NO USER SERVICEABLE PARTS INSIDE
REFER SERVICING TO QUALIFIED PERSONNEL**

THIS INFINITY PRODUCT IS DESIGNED FOR 120-VOLT USE ONLY! FOR DETAILED SAFETY PRECAUTIONS, PLEASE SEE FOLLOWING PAGE IN THIS OWNER'S MANUAL FOR "IMPORTANT SAFETY INSTRUCTIONS."

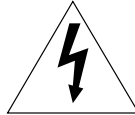

The lightning flash with arrowhead symbol, within an equilateral triangle, is intended to alert the user to the presence of uninsulated "dangerous voltage" within the product's enclosure that may be of sufficient magnitude to constitute a risk of electric shock to persons.



The exclamation point within an equilateral triangle is intended to alert the user to the presence of important operating and maintenance (servicing) instructions in the literature accompanying the product.

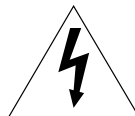

Éclair avec le symbole de la fêche, placé dans les limites dun triangle équilatéral est prévu pour avertir l'utilisateur de la présence de "tension dangereuse" non isolée dans l'enceinte du produit qui pourrait être d'une importance suffisante pour présenter un resque d'électrocution aux personnes.



Le point d'exclamation dans un triangle équilatéral est prévu pour avertir l'utilisateur de la présence d'instructions importantes pour les opérations et l'entretien (service) dans les manuels fournis avec l'appareli.

ATTENTION: POUR EVITER LES CHOCS ELECTRIQUES, INTRODUIRE LA LAME LA PLUS LARGE DE LA FICHE DANS LA BORNE CORRESPONDANTE DE LA PRISE ET POUSSER JUSQU'AU FOND.

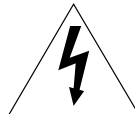

Este destello luminoso con un simbolo de punta de flecha dentro de un triángulo equilátero tiene el objetivo de alertar al usuario sobre la presencia de "voltaje peligroso" no aislado dentro de la caja del producto que puede ser de magnitud lo suficientemente grande para constituir un riesgo de choque eléctrico para las personas.



Este punto de exclamación dentro de un triángulo equilátero tiene el objetivo de alertar al usuario sobre la existencia de instrucciones operativas y de mantenimiento (servicio) importantes en la literatura que acompaña el aparato.

CUIDADO: PARA REDUCIR EL RIESGO DE CHOQUE ELÉCTRICO, NO RETIRE LA CUBIERTA (O RESPALDO). DENTRO NO HAY PEIZAS A LAS QUE EL USUARIO PUEDE DAR SERVICIO. REMITA EL SERVICIO AL PERSONAL DE SERVICIO CALIFICADO.

IMPORTANT SAFETY INSTRUCTIONS

1) Read Instructions – All the safety and operating instructions should be read before the product is operated.

2) Retain Instructions – The safety and operating instructions should be retained for future reference.

3) Heed Warnings – All warnings on the product and in the operating instructions should be adhered to.

4) Follow Instructions – All operating and use instructions should be followed.

5) Cleaning – Unplug this product from the wall outlet before cleaning. Do not use liquid cleaners or aerosol cleaners. Use a damp cloth for cleaning.

Exception: A product that is meant for uninterrupted service and that for some specific reason, such as the possibility of the loss of an authorization code for a CATV Converter, is not intended to be unplugged by the user for cleaning or any other purpose, may exclude the reference to unplugging the product in the cleaning description otherwise required in number 5.

6) Attachments – Do not use attachments not recommended by the product manufacturer as they may cause hazards.

7) Water and Moisture – Do not use this product near water – for example, near a bathtub, washbowl, kitchen sink, or laundry tub; in a wet basement; or near a swimming pool; and the like.

8) Accessories – Do not place this product on an unstable cart, stand, tripod, bracket, or table. The product may fall, causing serious injury to a child or adult, and serious damage to the product. Use only with a cart, stand, tripod, bracket, or table recommended by the manufacturer, or sold with the product. Any mounting of the product should follow the manufacturer's instructions, and should use a mounting accessory recommended by the manufacturer.



9) A Product and Cart Combination Should Be Moved With Care – Quick stop, excessive force, and uneven surfaces may cause the product and cart combination to overturn.

10) Ventilation – Slots and openings in the cabinet are provided for ventilation and to ensure reliable operation of the product and to protect it from overheating, and these openings must not be blocked or covered. The openings should never be blocked by placing the product on a bed, sofa, rug, or other similar surface. This product should not be placed in a built-in installation such as a bookcase or rack unless proper ventilation is provided or the manufacturer's instructions have been adhered to.

11) Power Sources – This product should be operated only from the type of power source indicated on the marking label. If you are not sure of the type of power supply to your home, consult your product dealer or local power company. For products intended to operate from battery power, or other sources, refer to the operating instructions.

12) Grounding or Polarization – This product may be equipped with a polarized alternating-current-line plug (a plug having one blade wider than the other). This plug will fit into the power outlet only one way. This is a safety feature. If you are unable to insert the plug fully into the outlet, try reversing the plug. If the plug should still fail to fit, contact your electrician to replace your obsolete outlet. Do not defeat the safety purpose of the polarized plug.

13) Power-Cord Protection – Power-supply cords should be routed so that they are not likely to be walked on or pinched by items placed upon or against them, paying particular attention to cords at plugs, convenience receptacles, and the point where they exit from the product.

14) Outdoor Antenna Grounding – If an outside antenna or cable system is connected to the product, be sure the antenna or cable system is grounded so as to provide some protection against voltage surges and built-up static charges. Article 810 of the National Electrical Code, ANSI/NFPA 70, provides information with regard to proper grounding of the mast and supporting structure, grounding of the lead-in wire to an antenna discharge unit, size for grounding conductors, location of antenna-discharge unit, connection to grounding electrodes, and requirements for the grounding electrode. See Figure A.

15) Lightning – For added protection for this product during a lightning storm, or when it is left unattended and unused for long periods of time, unplug it from the wall outlet and disconnect the antenna or cable system. This will prevent damage to the product due to lightning and power-line surges.

16) Power Lines – An outside antenna system should not be located in the vicinity of overhead power lines or other electric light or power circuits, or where it can fall into such power lines or circuits. When installing an outside antenna system, extreme care should be taken to keep from touching such power lines or circuits as contact with them might be fatal.

17) Overloading – Do not overload wall outlets, extension cords, or integral convenience receptacles as this can result in a risk of fire or electric shock.

18) Object and Liquid Entry – Never push objects of any kind into this product through openings as they may touch dangerous voltage points or short out parts that could result in a fire or electric shock. Never spill liquid of any kind on the product.

19) Servicing – Do not attempt to service this product yourself as opening or removing covers may expose you to dangerous voltage or other hazards. Refer all servicing to qualified service personnel.

Figure A.

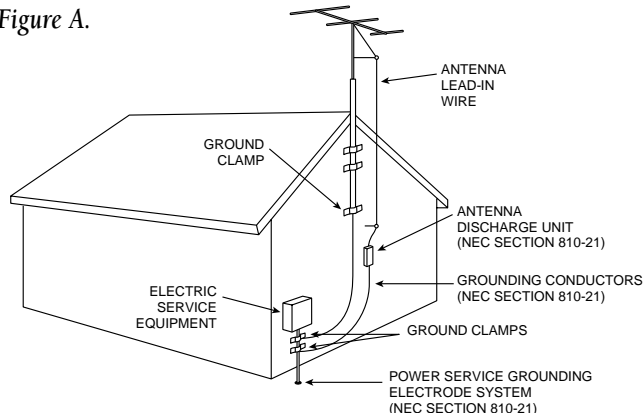

20) Damage Requiring Service – Unplug this product from the wall outlet and refer servicing to qualified service personnel under the following conditions:

- When the power-supply cord or plug is damaged.
- If liquid has been spilled, or objects have fallen into the product.
- If the product has been exposed to rain or water.
- If the product does not operate normally by following the operating instructions. Adjust only those controls that are covered by the operating instructions as an improper adjustment of other controls may result in damage and will often require extensive work by a qualified technician to restore the product to its normal operation.
- If the product has been dropped or damaged in any way.
- When the product exhibits a distinct change in performance – this indicates a need for service.

21) Replacement Parts – When replacement parts are required, be sure the service technician has used replacement parts specified by the manufacturer or that have the same characteristics as the original part. Unauthorized substitutions may result in fire, electric shock, or other hazards.

22) Safety Check – Upon completion of any service or repairs to this product, ask the service technician to perform safety checks to determine that the product is in proper operating condition.

23) Wall or Ceiling Mounting – The product should be mounted to a wall or ceiling only as recommended by the manufacturer.

24) Heat – The product should be situated away from heat sources such as radiators, heat registers, stoves, or other products (including amplifiers) that produce heat.

THE REFERENCE SERIES (RS)

All RS Series products use efficient drivers for maximum output with minimal amplifier power. They are magnetically shielded, making them suitable for home-theater applications as well.

UNPACKING THE SPEAKERS

If you suspect damage from transit, report it immediately to your dealer and/or delivery service. Keep the shipping carton and packing materials for future use.

These speakers are covered by a Limited Warranty, so save the sales receipt to protect your purchase and aid in any service-related questions. Also, save these instructions for future reference.

INSTALLING FEET

Refer to Figure 1 as you perform the following steps:

1. Open each accessory pack and locate the following items: four feet (with spike/round ends), four locking nuts, four nylon domes and one wrench.
2. Lay each speaker on its side and locate the four threaded holes on the bottom.
3. For carpets, screw the round end of a foot into each hole and hand tighten a nut onto each one. Leave a minimum of $\frac{5}{8}$ " exposed spike. (On thicker carpets, you can increase the length of exposed spike up to $1\frac{1}{8}$ ".) For hard-surface floors, screw the spike end into each hole instead and leave $\frac{5}{8}$ " of round end exposed.
4. Carefully flip each speaker upright to sit on its feet.
5. If needed, adjust the feet so each speaker is level and then tighten each nut with the enclosed wrench. To protect hard surfaces (e.g., wood floors), slip a nylon dome onto each round end.

Figure 1. This cross section shows how to install a foot onto the bottom of an RS floorstanding speaker.

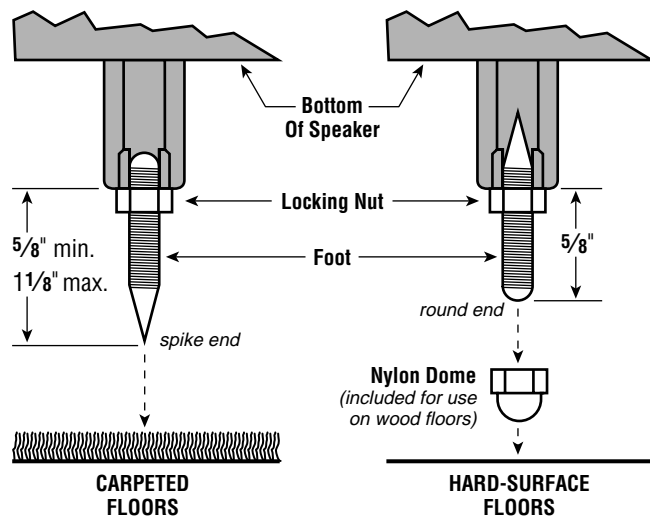

STEREO-SPEAKER PLACEMENT...

Figure 2.

PLANNING YOUR SYSTEM

Before deciding where to put your RS Series floorstanding speakers, survey your room and think about placement, keeping the following points in mind:

- ◆ Take care in placing the speakers in their correct left and right orientation (side-firing 8" subwoofer facing out).
- ◆ For best results, try placing the speakers 6' – 8' apart.
- ◆ Optimum listening position is achieved by sitting at the vertex of an equilateral triangle formed by the speakers and the listening position (see Figure 2).

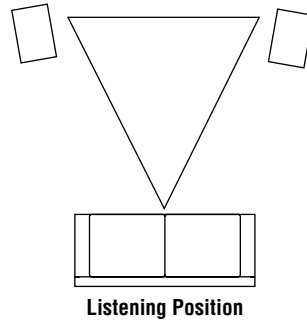

- ◆ Refer to Figure 3 when placing speakers for best bass level and stereo image (see *Final Adjustments* on page 9).

Figure 3. Experiment with speaker placement to obtain the best bass level and stereo imaging in your room.

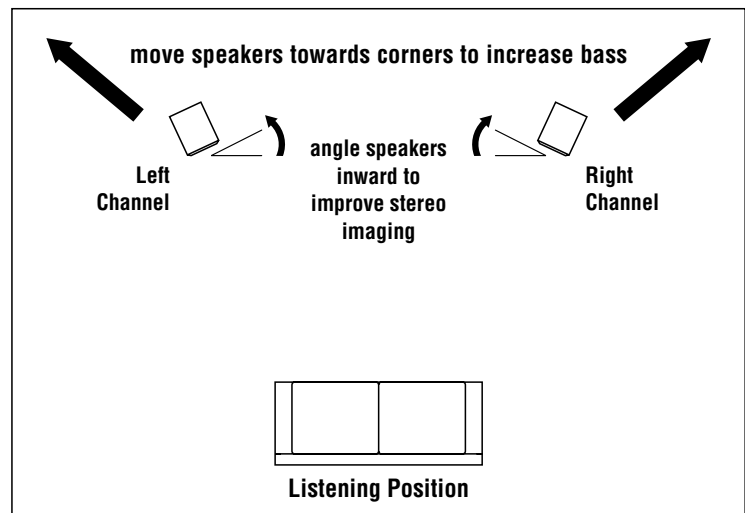

HOME-THEATER PLACEMENT...

RS-8 and RS-10 speakers are also suitable for use in reproducing home-theater sound from front left and right channels.

Place one speaker on the left and another on the right, along either side of the television monitor. Since the speakers are magnetically shielded, you can set them in very close without worrying about the magnetic field distorting the TV picture.

NOTE: For maximum home-theater enjoyment, your audio system should also include a center-channel speaker and a pair of rear-surround speakers. Contact your local Infinity dealer for recommendations on adding these home-theater speakers to your system.

TURN OFF ALL POWER...

WIRING THE SYSTEM

IMPORTANT: Make sure all equipment is turned off before making any connections.

Connection Tips

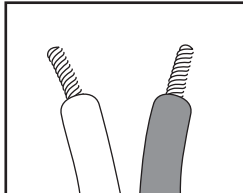

Speakers and electronics terminals have corresponding (+) and (-) terminals. It is important to connect both speakers identically: (+) on the speaker to (+) on the amplifier and (-) on the speaker to (-) on the amplifier. Wiring “out of phase” results in thin sound, weak bass and a poor stereo image.

If your receiver does not have a subwoofer output:

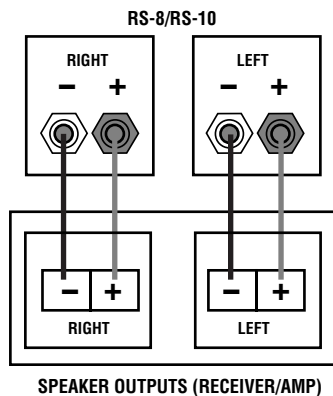

Set Input Select switch to “Speaker.”

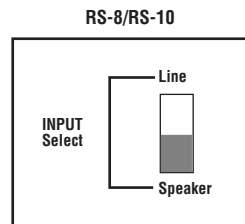

WIRING THE SYSTEM (Continued)

If your receiver has a subwoofer output:

The RS-8 and RS-10 incorporate two different types of line-level inputs that allow you to optimize the loudspeakers' performance in your system.

If your receiver/processor's subwoofer output is already low-passed filtered, meaning the high frequencies have been removed by the receiver, use the subwoofer input labeled **Direct**.

If your receiver/processor's subwoofer output is full range, meaning the high frequencies have not been removed by the receiver, use the subwoofer input labeled **Normal**.

If you are unsure as to which type of subwoofer output your receiver/processor contains, please consult your receiver/processor owner's manual or contact the manufacturer.

Do not hook up both inputs. Doing so will adversely affect the performance of the system.

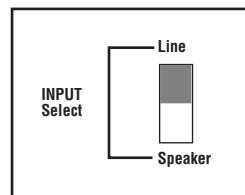
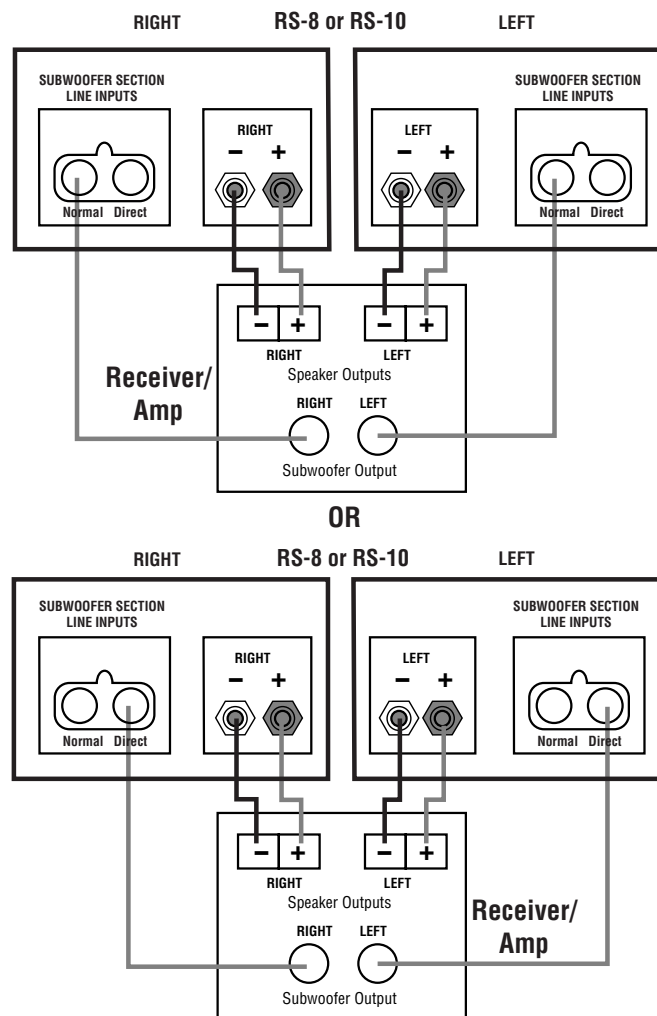

Set Input Select switch to "Line."

NOTE: Some receivers/amplifiers have a single (mono) subwoofer output. In this case, it is necessary to use a "Y"-connector (not included) to properly hook up the speakers using this method.

FINAL ADJUSTMENTS

Turn the power switch to the “on” position.

The RS-8/RS-10 includes an auto-on/auto-off circuit for the powered subwoofer. When the on/auto switch is set to the “on” position, the subwoofer amplifier is receiving power. When the switch is set to the “auto” position, the subwoofer amplifier will turn itself off after receiving no signal for approximately 5 – 10 minutes. It will then turn itself on instantly when a signal is received.

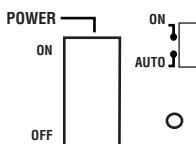

Check the speakers for playback, first by setting the system volume control to a minimum level and then by applying power to your audio system. Play a favorite music or video segment and increase the system volume control to a comfortable level.

NOTE: You should hear balanced audio reproduction across the entire frequency spectrum. If not, check all wiring connections or, for more help, consult the Authorized Infinity Dealer where you purchased the system.

The amount of bass you hear will be affected by a number of different factors, including the room's size and shape, the construction materials used to build the room, the listener's position relative to the speakers and the position of the speakers in the room.

To fine-tune the bass output, simply adjust the level control at the rear of the speaker.

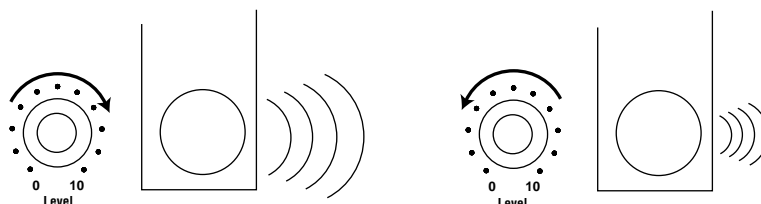

Listen to a variety of music selections and note the bass level. Increase or decrease to the level you prefer.

CARE OF YOUR SPEAKER SYSTEM

Each RS Series cabinet has a wood-vinyl finish that does not require any routine maintenance. When needed, use a soft cloth, dampened with water only, to remove any fingerprints or to wipe off dust.

Clean the grille by gently vacuuming or wiping with a damp cloth.

NOTE: Do not use any cleaning products or polishes on the cabinet or grille.

TROUBLESHOOTING

If there is no sound from any of the speakers, check the following:

- Receiver/amplifier is on and a source is playing.
- Review proper operation of your receiver/amplifier.

If there is no sound coming from one speaker, check the following:

- Check the “Balance” control on your receiver/amplifier.
- Check all wires and connections between receiver/amplifier and speakers.
- Make sure all wires are connected. Make sure none of the speaker wires are frayed, cut or punctured.

If the system plays at low volumes but shuts off as volume is increased, check the following:

- Check all wires and connections between receiver/amplifier and speakers.
- Make sure all wires are connected. Make sure none of the speaker wires are frayed, cut or punctured.
- If more than one pair of main speakers is being used, check the minimum impedance requirements of your receiver/amplifier.

If you used the high-level (speaker) inputs only and there is no sound from any of the speakers, check the following:

- Receiver/amplifier is on and a source is playing.
- Make sure the input select switch is set to “Speaker.”
- Check all wires and connections between receiver/amplifier and speakers. Make sure all wires are connected. Make sure none of the speaker wires are frayed, cut or punctured.
- Review proper operation of your receiver/amplifier.

If there is low bass output, check the following:

- Make sure the connections to the left and right “Speaker Inputs” have the correct polarities (+ and –).
- Make sure that the speaker is plugged into an active electrical outlet.
- Adjust the subwoofer-level control.
- Make sure the input-select switch is in the correct position (pages 7, 8).

If you used the line-level inputs and there is no sound from the subwoofer, check the following:

- Receiver/amplifier is on and a source is playing.
- Make sure the input-select switch is set to “Line.”
- RS-8/RS-10 is plugged in.
- Check all wires and connections between receiver/amplifier and speakers. Make sure all wires are connected. Make sure none of the wires are frayed, cut or punctured.
- Review proper operation of your receiver/amplifier.

SPECIFICATIONS

PERFORMANCE DATA

	RS-8	RS-10
Recommended Amplifier Power:	15 ~ 175W	15 ~ 200W
Frequency Range:	32 ~ 20,000Hz	28 ~ 20,000Hz
Sensitivity: (2.83 V @ 1 m)	92dB	93dB
Nominal Impedance:	8 Ω	8 Ω
Subwoofer-Amplifier Power:	100W	150W

DRIVE UNITS

Bass:	8" (203mm)	10" (254mm)
Midbass:	6-1/2" (165mm)	Dual 5-1/4" (133mm)
High Frequency:	1" (25mm)	1" (25mm)

DIMENSIONS

Height, Width, Depth:	40 x 7-1/2 x 12-3/4" (1016 x 191 x 324mm)	44-1/4 x 7-1/2 x 17" (1124 x 191 x 432mm)
-----------------------	----------------------------------------------	----------------------------------------------

Infinity constantly strives to update and improve existing products, as well as create new ones. Therefore, the specifications and construction details in this and related Infinity publications are subject to change without notice.

© 1998 Infinity Systems, Inc., 250 Crossways Park Drive, Woodbury, NY 11797 USA
(800) 553-3332 (USA Only)
www.infinity.com

Infinity is a registered trademark of Infinity Systems, Inc.